

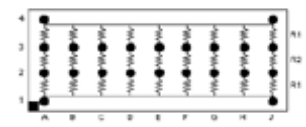







# Short Form Resistors



The following catalog products are recommended for new applications. If the product required is not shown, we may have a customized product for your application. Please contact your CTS Representative for availability.

Application	Picture	Configuration	Description					
LVD SCSI		 <p>Style C</p>	9 line differential terminator set designed to meet Ultra2 and Ultra 3 LVD SCSI standards.	<b>1.27mm Pitch Part Number</b>	<b>1.00mm Pitch Part Number</b>	<b>R1 W</b>	<b>R2 W</b>	
				RT1300B6	--	475	121	
				RT1320B6	--	330	150	
DDR SDRAM		 <p>Style H</p>	9 line integrated terminator set provides series termination at the source and parallel termination at the receiver. Designed to meet Jaded Std. 8-9a. +/- 1% tolerance.	<b>1.27mm Pitch Part Number</b>	<b>1.00mm Pitch Part Number</b>	<b>Style</b>	<b>R1 W</b>	<b>R2 W</b>
				RT1400B6	RT1400B7	H	50	25
				RT1401B6	RT1401B7	H	25	22
				RT1408B6	RT1408B7	H	60	25
				RT1402B6	RT1402B7	F	50	--
				RT1403B6	RT1403B7	F	25	--
				RT1407B6	RT1407B7	F	35	--
				RT1430B6	RT1430B7	F	60	--
				RT1432B6	RT1432B7	F	120	--
				RT1431B6	--	F	182	--
				RT1404B6	RT1404B7	C	25	--
				RT1405B6	RT1405B7	C	22	--
				RT1460B6	RT1460B7	C	50	--
RT1463B6	RT1463B7	C	33	--				
RT1465B6	RT1465B7	C	47	--				
RT1466B6	RT1466B7	H	51	22				
		 <p>Style F</p>						
		 <p>Style C</p>						



# Terminators

The following catalog products are recommended for new applications. If the product required is not shown, we may have a customized product for your application. Please contact your CTS Representative for availability.

Application	Picture	Configuration	Description					
Compact PCI, IDE, DRAM, SDRAM		<p>Style C</p>	16 line or 32 line terminator provides series termination at the source. Designed for CompactPCI PC card and memory applications. Standard resistance tolerance +/-1%	1.27mm Pitch Part Number	1.00mm Pitch Part Number	R1 W	Array	
				--	RT1200B7	10	121	
				--	RT1201B7	10	150	
				--	RT1202B7	33		
				--	RT1203B7	33		
GTL		<p>Style D</p>	8, 16 or 32 line terminator provides parallel termination at the receiver. Designed with star pattern to minimize crosstalk and improve high frequency performance. Tolerance +/- 1%	1.27mm Pitch Part Number	1.00mm Pitch Part Number	R1 W	Lines	Array Size
				--	RT1100B7	22		3 x 3
				RT1101B6	RT1101B7	22		3 x 6
				RT1102B7	RT1102B7	22		3 x 9
				RT1450B6	--	25	8	3 x 3
				RT1451B6	--	25	8	3 x 6
				RT1452B6	--	25	16	3 x 12
				RT1453B6	--	56	16	3 x 3
				RT1454B6	--	56		3 x 6
				RT1427B6	--	56		3 x 12
				RT1410B6	--	150		3 x 3
				RT1411B6	--	150		3 x 6
				RT1412B6	RT1412B7	150		3 x 12



## Terminators



The following catalog products are recommended for new applications. If the product required is not shown, we may have a customized product for your application. Please contact your CTS Representative for availability.

Application	Picture	Configuration	Description	Description				
PCI		<p>RT1417, RT1418 - 16 Bits</p> <p>Style F</p>	8 or 16 line bias network provides pull-up or pull-down to reference voltage. Designed for PCI and PCIX applications. Standard tolerance +/-1%	1.27mm Pitch Part Number	1.00mm Pitch Part Number	R1 W	Lines	Array Size
				RT1415B6	RT1415B7	4.7K	8	3 x 4
				RT1416B6	RT1416B7	8.2K	8	3 x 4
				RT1417B6	RT1417B7	4.7K	16	3 x 8
				RT1418B6	RT1418B7	8.2K	16	3 x 8
LVPECL		<p>Style G</p>	8 line terminator network provides Thevenin termination. Designed for LVPECL applications. Standard resistor tolerance is ±1%	1.27mm Pitch Part Number	1.00mm Pitch Part Number	R1 W	R2 W	
				RT1250B6	RT1250B7	127	82.5	
VME		<p>Style G</p>	8 line terminator network provides Thevenin termination. Designed for VME64 and VME64x applications. Standard resistance tolerance is +/-1%	1.27mm Pitch Part Number	1.00mm Pitch Part Number	R1 W	R2 W	
				--	RT1210B7	330	470	
				--	RT1211B7	220	1.8K	

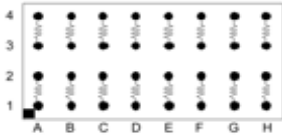

# Terminators

The following catalog products are recommended for new applications. If the product required is not shown, we may have a customized product for your application. Please contact your CTS Representative for availability.

Application	Picture	Configuration	Description					
FPGA/LVDS		<p style="text-align: center;"><b>RT1710 RX Termination</b></p>  <p style="text-align: center;">Style C</p>	<p>These LVPECL and LVDS termination networks are designed for high performance termination of differential Input/Output signals on some of the most popular Field Programmable Gate Arrays (FPGAs). Designed for termination of Xilinx® and Altera® FPGAs. 8 or 16 differential channels of termination provided in a single integrated package.</p>	<b>1.27mm Pitch Part Number</b>	<b>1.00mm Pitch Part Number</b>	<b>R1 W</b>	<b>R2 W</b>	<b>Array Size</b>
		RT1710B6		RT1710B7	100		4 x 8	
		--		RT1720B7	187	100	4 x 16	
		RT1721B6		RT1721B7	187	100	4 x 8	
		--		RT1722B7	140	165	4 x 16	
		RT1723B6		RT1723B7	140	165	4 x 8	
		--		RT1724B7	140	135	4 x 16	
		RT1725B6		RT1725B7	140	135	4 x 8	
		<p style="text-align: center;"><b>RT1720, RT1722, RT1724 TX Termination</b></p>  <p style="text-align: center;">Style I</p>						



# Terminators

The following catalog products are recommended for new applications. If the product required is not shown, we may have a customized product for your application. Please contact your CTS Representative for availability.

Mechanical Design	1.27 mm Pitch Package (B6 suffix)			1.00 mm Pitch Package (B7 suffix)		
		mm	inch		mm	inch
		P	1.27±0.25	.050±.010	P	1.00±0.25
	D	0.76±0.05	.030±.002	D	0.64±0.05	.025±.002
	K	0.64±0.25	.025±.010	K	0.50±0.25	.020±.010
	H	1.32±0.15	.052±.006	H	1.19±0.15	.047±.006
	Array Size	L	W	Array Size	L	W
	3 x 3	mm 3.81±0.15	mm 3.81±0.15	3 x 4	mm 4.00±0.15	mm 3.00±0.15
		inch .150±.006	inch .150±.006		inch .157±.006	inch .118±.006
	3 x 4	mm 5.08±0.15	mm 3.81±0.15	3 x 8	mm 8.00±0.15	mm 3.00±0.15
		inch .200±.006	inch .150±.006		inch .315±.006	inch .118±.006
	3 x 6	mm 7.62±0.15	mm 3.81±0.15	3 x 9	mm 9.00±0.15	mm 3.00±0.15
		inch .300±.006	inch .150±.006		inch .354±.006	inch .118±.006
	3 x 8	mm 10.16±0.15	mm 3.81±0.15	3 x 12	mm 12.00±0.15	mm 3.00±0.15
		inch .400±.006	inch .150±.006		inch .472±.006	inch .118±.006
	3 x 9	mm 11.43±0.15	mm 3.81±0.15	4 x 8	mm 8.00±0.15	mm 4.00±0.15
		inch .450±.006	inch .150±.006		inch .315±.006	inch .157±.006
	3 x 12	mm 15.24±0.15	mm 3.81±0.15	4 x 9	mm 9.00±0.15	mm 4.00±0.15
		inch .600±.006	inch .150±.006		inch .354±.006	inch .157±.006
4 x 9	mm 11.43±0.15	mm 5.08±0.15	4 x 16	mm 16.00±0.15	mm 4.00±0.15	
	inch .450±.006	inch .200±.006		inch .630±.006	inch 0.157	



# Terminators

The following catalog products are recommended for new applications. If the product required is not shown, we may have a customized product for your application. Please contact your CTS Representative for availability.

## Recommended Land Pattern

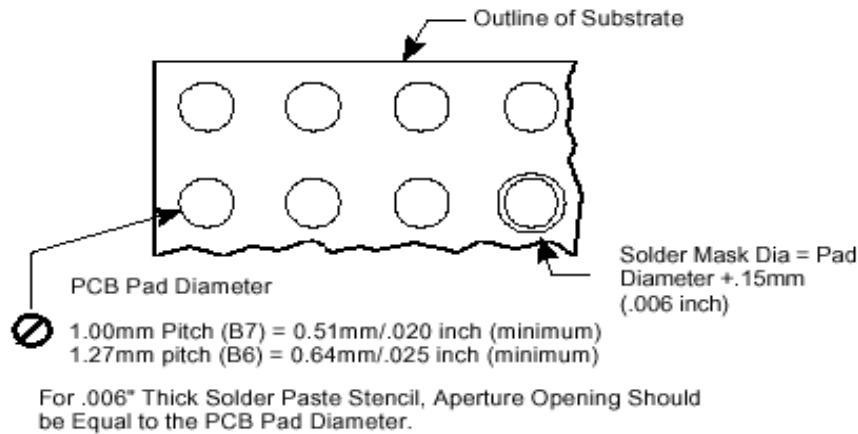

## Part Number Coding

7 inch reel, Add TR7 to part number, example RT1415B7TR7

13 inch reel, Add TR13 to part number, example RT1415B7TR13

(Bulk packaging is not available)

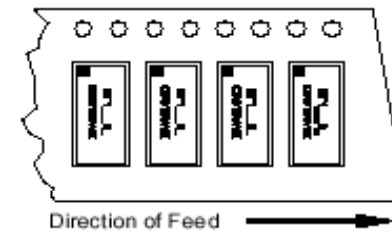

Packaging Information		
Suffix	TR7	TR13
Tape Width	24 mm	24 mm
Carrier Pitch	8 mm	8 mm
Reel Diameter	7 inch	13 inch
Parts/Reel	1,000	4,000

Electrical Specifications	
Resistor Tolerance	± 1.0%
TCR	± 200ppm/°C
Operating Temperature Range	-55°C to +125°C
Maximum Resistor Power	0.05 Watts minimum at 70°C
Maximum Package Power	1.0 Watts at 70°C



# Terminators

The following catalog products are recommended for new applications. If the product required is not shown, we may have a customized product for your application. Please contact your CTS Representative for availability.

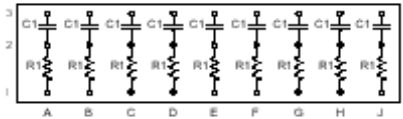
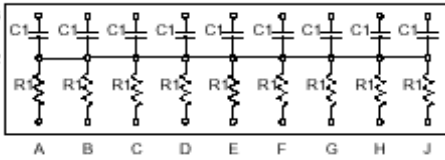
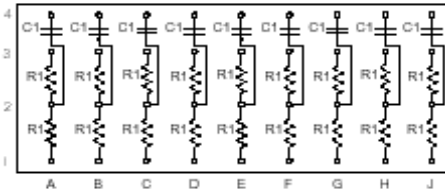
ClearONE Resistor/Capacitor Ball Grid Array Package									
<p>R/C BGA</p> 	 <p>Style J</p>	<p>This Resistor/Capacitor terminator network provides high performance termination.</p>	1.27mm Pitch Part Number	1.00mm Pitch Part Number	R1 Ω	Tolerance R1			
				RC3001B6 <sup>1</sup>		50	± 1%		
				RC3002B6	RC3002B7	50	± 1%		
				RC3003B6 <sup>1</sup>	--	50	± 1%		
				RC3004B6 <sup>1</sup>		50	± 1%		
				RC3005B6		50	± 1%		
				RC3007B6		50	± 1%		
				RC3008B6		50	± 1%		
	 <p>Style K</p>	<p>Designed with a ceramic substrate, this device virtually eliminates channel capacitance, a primary cause of reduced system performance. In addition, the BGA package eases routing design, saving the designer many hours of printed circuit layout.</p>	1.27mm Pitch Part Number	1.00mm Pitch Part Number	C1	Cap Tolerance	Dielectric	DF Max	
				RC3001B6 <sup>1</sup>		33pf	± 10%	NPO	2.50%
				RC3002B6	RC3002B7	0.1uf	± 10%	X5R	5%
				RC3003B6 <sup>1</sup>	--	0.1uf	± 10%	X5R	5%
				RC3004B6 <sup>1</sup>		100pf	± 10%	NPO	2.50%
				RC3005B6		0.1uf	± 10%	X5R	5%
				RC3007B6		100pf	± 10%	NPO	2.50%
		RC3008B6		33pf	± 10%	NPO	2.50%		
 <p>Style L</p>		<p>Note 1: These are obsolete encapsulated designs. Only the un-encapsulated part numbers may be ordered. RC3005B6 replaces RC3003B6, RC3007B6 replaces RC3004B6, and RC3008B6 replaces RC3001B6.</p>							

The following catalog products are recommended for new applications. If the product required is not shown, we may have a customized product for your application. Please contact your CTS Representative for availability.

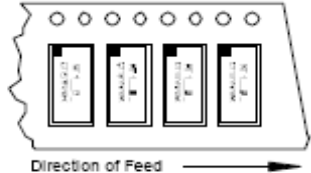
<p><b>Part Number Coding</b> 7 inch reel, Add TR7 to part number, example RC3001B6TR7</p> <p>13 inch reel, Add TR13 to part number, example RC3001B6TR13</p> <p>(Bulk packaging is not available)</p> 	R/C Electrical Specifications		
	Resistor Tolerance		± 1.0%
	TCR		± 200ppm/°C
	Operating Temperature Range		-55°C to +125°C (with NPO capacitors) -55°C to +85°C (with X5R capacitors)
	Maximum Resistor Power		0.05 Watts minimum at 70°C (Not to exceed total package power)
	Maximum Package Power		1.0 Watts at 70°C
	Maximum Processing Temperature		225°C, 30 sec. (Encapsulated Design - Obsolete) 225°C, 30 sec. (Un-encapsulated Design)
	Note: Maximum resistor power will vary by resistance value		
	R/C Packaging Information		
	Suffix	TR7	TR13
Tape Width	24 mm	24 mm	
Carrier Pitch	8 mm	8 mm	
Reel Diameter	7 inch	13 inch	
Parts/Reel	750	3,000	

R/C Ordering Information									
1.27mm Pitch Part Number	1.00mm Pitch Part Number	Style	Array Size	R1 Ω	Tolerance R1	C1	Cap Tolerance	Dielectric	DF
RC3001B6 <sup>1</sup>		J	3 x 9	50	± 1%	33pf	± 10%	NPO	2.5% max
RC3002B6	RC3002B7	K	3 x 9	50	± 1%	0.1uf	± 10%	X5R	5% max
RC3003B6 <sup>1</sup>	--	L	4 x 9	50	± 1%	0.1uf	± 10%	X5R	5% max
RC3004B6 <sup>1</sup>		J	3 x 9	50	± 1%	100pf	± 10%	NPO	2.5% max
RC3005B6	--	L	4 x 9	50	± 1%	0.1uf	± 10%	X5R	5% max
RC3007B6		J	3 x 9	50	± 1%	100pf	± 10%	NPO	2.5% max
RC3008B6		J	3 x 9	50	± 1%	33pf	± 10%	NPO	2.5% max

Note 1: These are obsolete encapsulated designs. Only the un-encapsulated part numbers may be ordered. RC3005B6 replaces RC3003B6, RC3007B6 replaces RC3004B6, and RC3008B6 replaces RC3001B6.

The following catalog products are recommended for new applications. If the product required is not shown, we may have a customized product for your application. Please contact your CTS Representative for availability.

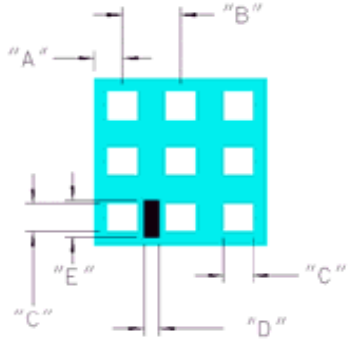
ClearONE Topside Probable Diagnostic Parts																											
Topside Probable Parts		<p>In general, all ClearONE designs can be made available in Top Probe-Able versions upon request. Many of the standard products are available off-the-shelf, but your local CTS ClearONE representative should be contacted for specific device ordering and availability details. Figure 1 describes the proper numbering to convert a standard ClearONE part number to the Top Probe-Able version. (See Topside Probable Application Note for more information.)</p>	<p>Standard ClearONE → Top Probe-Able ClearONE</p> <p>RT1404B7 → RT1404B7P</p> <p>Figure 1</p>																								
			<table border="1"> <thead> <tr> <th rowspan="2">DIM Metric/English</th> <th colspan="2">"Pitch Suffix"</th> </tr> <tr> <th>B6</th> <th>B7</th> </tr> </thead> <tbody> <tr> <td>"A"</td> <td>0.64/.025</td> <td>0.50/.020</td> </tr> <tr> <td>"B"</td> <td>1.27/.050</td> <td>1.00/.039</td> </tr> <tr> <td>"C"</td> <td>0.64/.025</td> <td>0.50/.020</td> </tr> <tr> <td>"D"</td> <td>0.66/.026</td> <td>0.50/.020</td> </tr> <tr> <td>"E"</td> <td>0.71/.028</td> <td>0.28/.011</td> </tr> <tr> <td>"F"</td> <td>0.66/.026</td> <td>0.66/.026</td> </tr> </tbody> </table>	DIM Metric/English	"Pitch Suffix"		B6	B7	"A"	0.64/.025	0.50/.020	"B"	1.27/.050	1.00/.039	"C"	0.64/.025	0.50/.020	"D"	0.66/.026	0.50/.020	"E"	0.71/.028	0.28/.011	"F"	0.66/.026	0.66/.026	
			DIM Metric/English		"Pitch Suffix"																						
B6	B7																										
"A"	0.64/.025	0.50/.020																									
"B"	1.27/.050	1.00/.039																									
"C"	0.64/.025	0.50/.020																									
"D"	0.66/.026	0.50/.020																									
"E"	0.71/.028	0.28/.011																									
"F"	0.66/.026	0.66/.026																									
Figure 2 — Probe Pad Layout																											



## Resistor Networks Solutions

### *Chip Resistor Array*

Photo	Series	Description
	740X	New 0201 size
	741C, 742C, 743C, 744C, 745C	Concave Termination
	741X, 742X, 745X, 746X	Convex Termination

### *Surface Mount Leadless SIP*

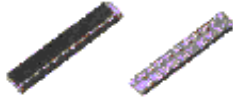
Photo	Series	Description
	752	SIP Surface Mount .050" Pitch
	753	SIP Surface Mount .025" Pitch



## Resistor Networks Solutions

### *Surface Mount with Gull Wing Leads*

Photo	Series	Description
	766	.150" Narrow Body
	767	.220" Medium Body
	768	.220" Medium Body

### *Through-Hole SIP*

Photo	Series	Description
	770	Conformal Coated



## Current Sensing Resistors

### *Very Low Resistance*

Photo	Series	Description	Resistance
	73M1, 73M2	Metal Plate	.003Ω to .100Ω
	73L1 - 73L7	Thick Film	.10Ω to .91Ω
	73E4, 73E6		.050Ω to .091Ω



## Ultra High Resistance Chip Resistor

### *Ultra High Resistance*

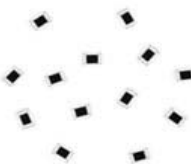
Photo	Series	Description	Resistance
	73U3	Thick Film	33MΩ to 100GΩ